

PRODUCT FEATURES:

- Adds a reverse camera input on select Mazda vehicles.
- Includes a universal license plate camera.

NOTES:

1. Vehicle must be equipped with a 7" touch screen Mazda Connect Infotainment system and a knob control behind the shifter.



2. The provided RCA cable with female pins must be inserted into the connector behind the OEM screen.

PARTS INCLUDED:



RVCMZ-72D MODULE



RVCMZ-72D HARNESS



LICENSE PLATE CAMERA

INSTALLATION:

2017 Mazda MX-5 (Miata) dash removal: Some pictures are of a Mazda 3 but similar in removal.



1. Partially remove dash trim below the AC vent by gently pulling towards you with a panel remover. Avoid removing it completely as it will be difficult to put back in.
2. With the dash trim out of the way, remove the AC vent by gently pulling it out. Use a panel removal tool if necessary.



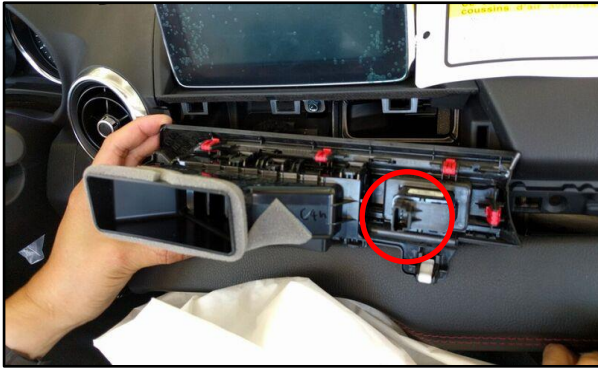

3. Unplug the hazard light connector from behind the AC vent.

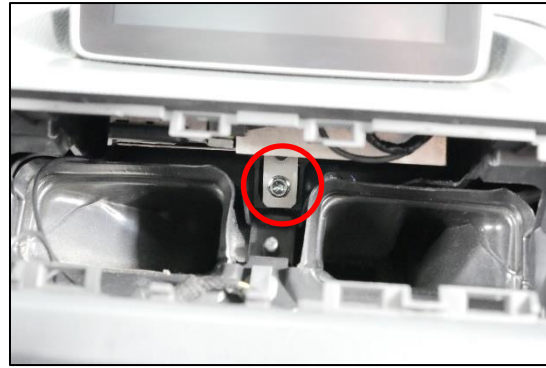

4. With the AC vent removed, unscrew the 10mm bolt holding the radio screen.



5. Once the 10mm bolt is removed, the radio screen assembly is secured with clips. Gently pull the assembly until it pops out.

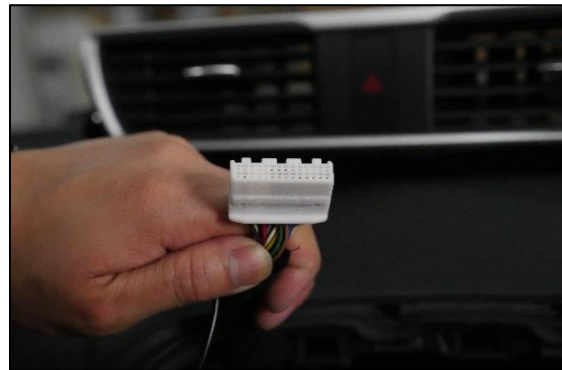

6. Unplug the 28 pin connector from behind the radio screen.



7. Release the terminal lock by pulling it up with a pry tool or any pointed tool. The terminal lock does not fully remove!

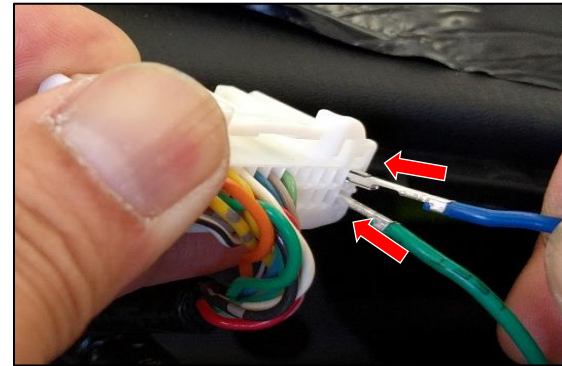

8. Connect the video output wires by inserting the BLUE wire (Video signal ground) into PIN 1 and the GREEN wire (Video signal +) into PIN 15. Make sure that the pins are inserted far enough into the connector to lock in place. Press down the terminal lock to lock pins in place.



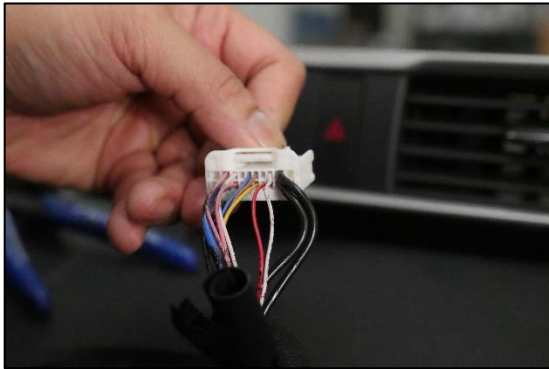

9. Unplug the 18 pin connector and locate the following wires:
 RED CAN wire
 WHITE CAN wire
 BLACK Ground wire
 YELLOW +12V

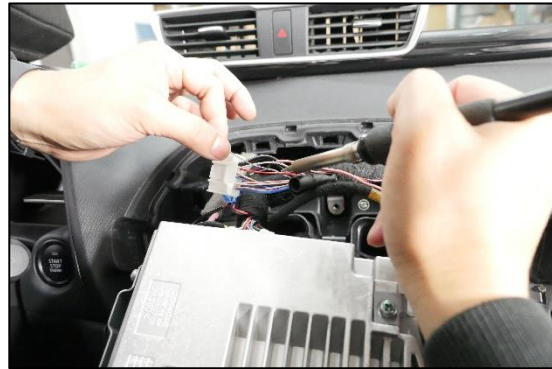

10. Tap the wires from the RVCMZ-72D module harness to the OEM connector wires according to the diagram below. We recommend soldering for a secure connection.

WIRING DIAGRAM:

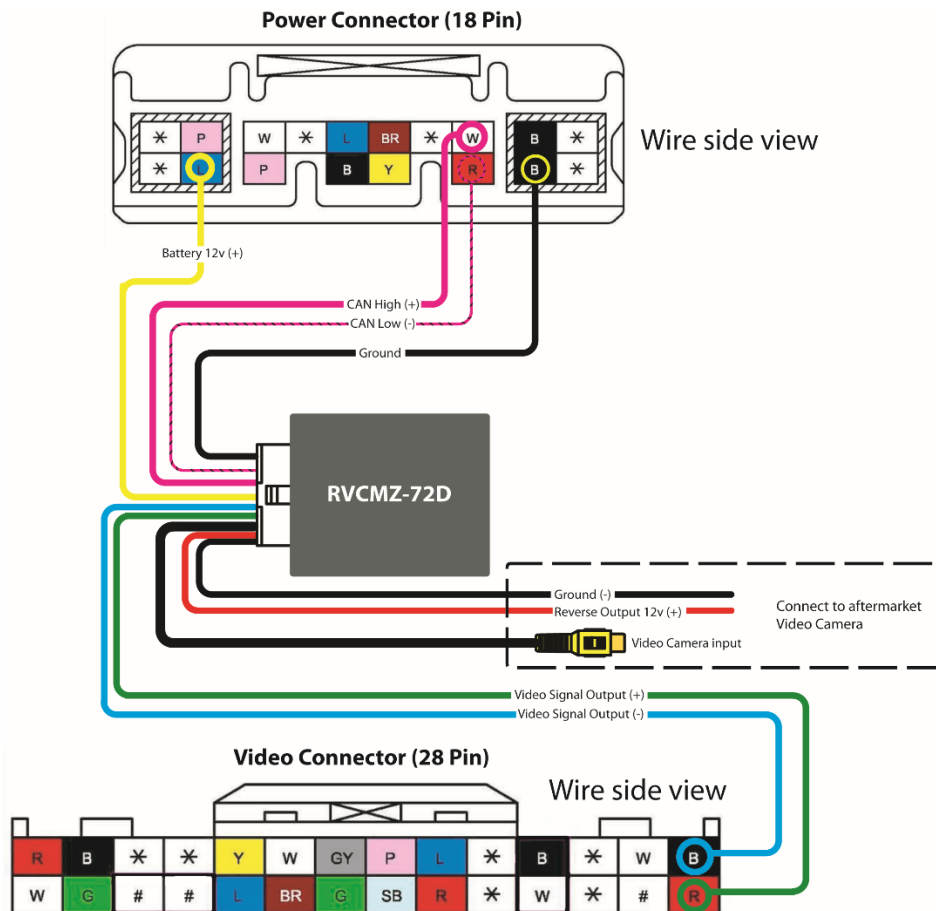

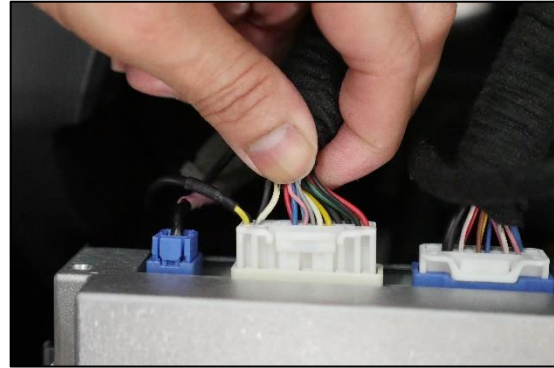
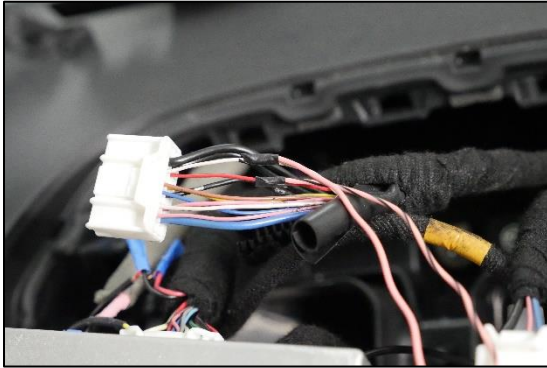

11. Apply tape to the connections.
12. Plug the factory connectors back into the radio and temporarily place radio back into the dash for testing.
13. Install the camera behind the vehicle. Run the camera extension cable towards the radio and plug it into the Yellow RCA of the RVCMZ-72D harness.
14. Start the vehicle and test the system by putting the vehicle in reverse gear. The camera image will be shown on the OE screen.
15. If the back up camera image does not show on the screen when the gear is shifted to reverse, reboot the Connect System. Press and hold the NAV and MUTE buttons on the Connect knob simultaneously for about 10 to 15 seconds. Once the radio has rebooted, put the gear in reverse and check if the back up camera image now shows on the OE screen.
16. Reinstall the factory radio and panels.

VEHICLE APPLICATIONS:

MAZDA

2014	3
2015 – 2017	3, 6, CX-3, CX-5 MX-5

